

中学生男子シングルス(52)

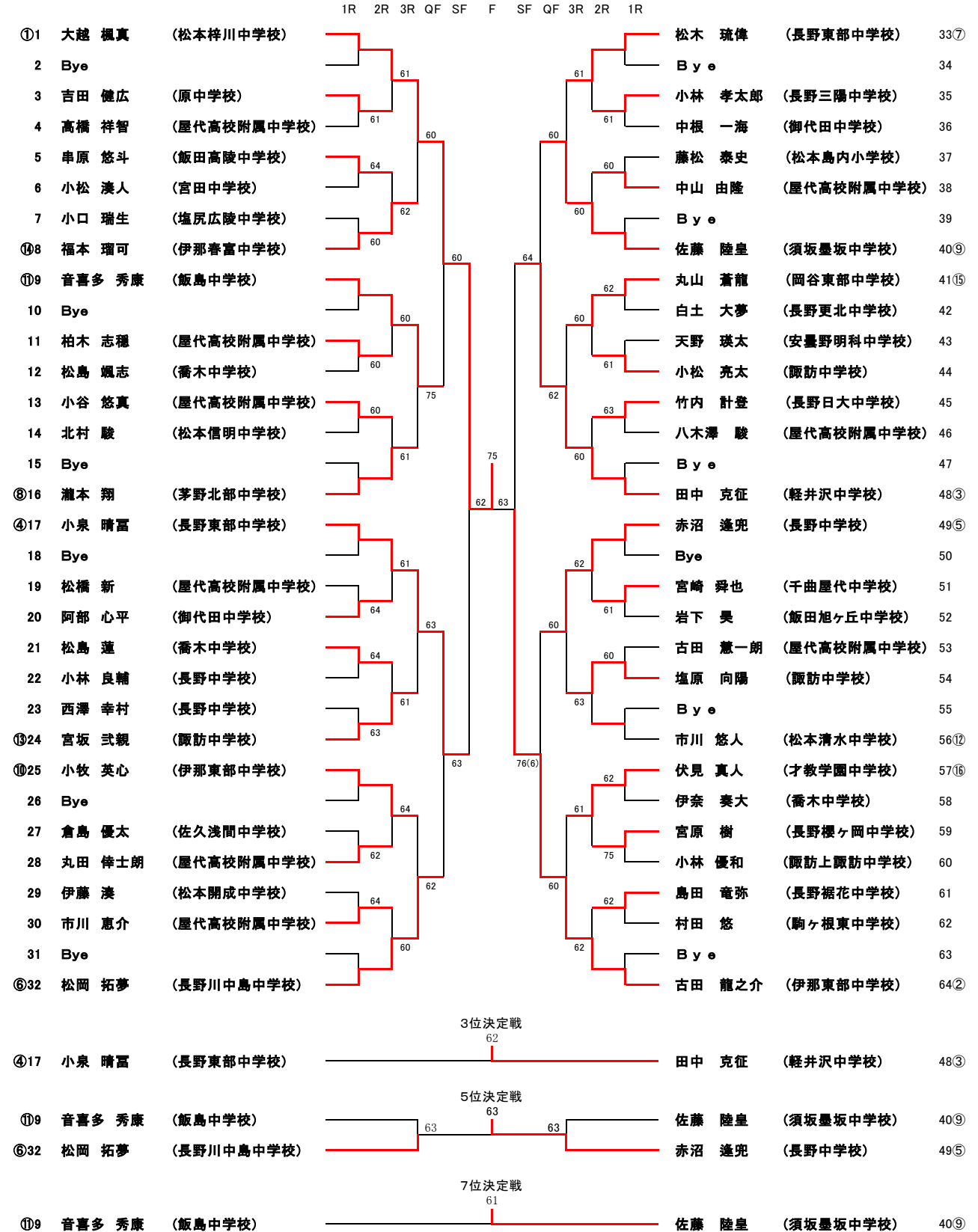

中学女子シングルス(24)

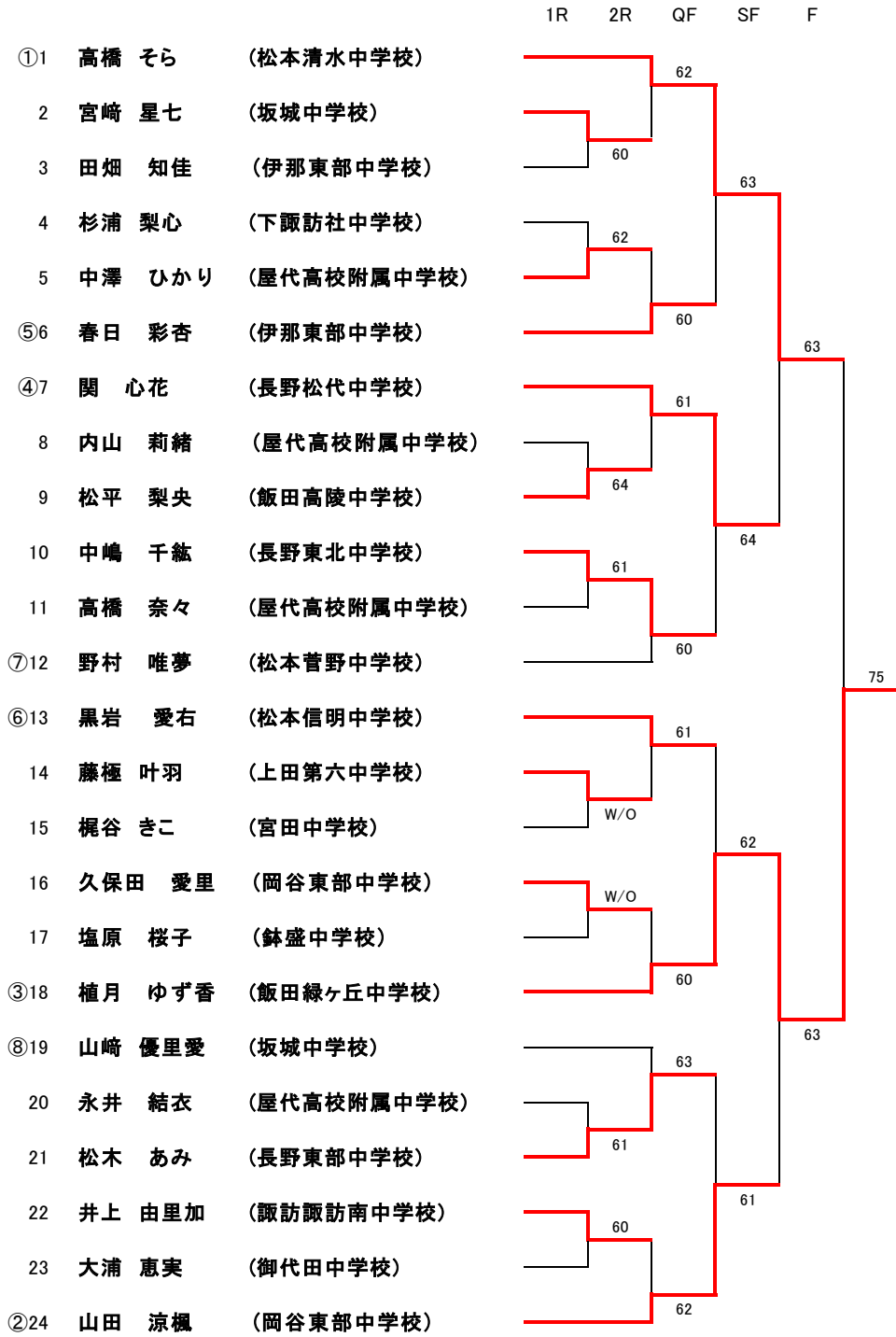

シングルス順位決定戦

3位決定戦



5・6位決定戦

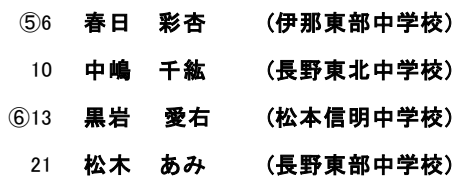

7・8位決定戦

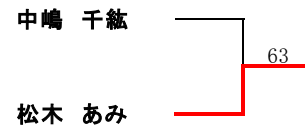

# 中学男子ダブルス(5)

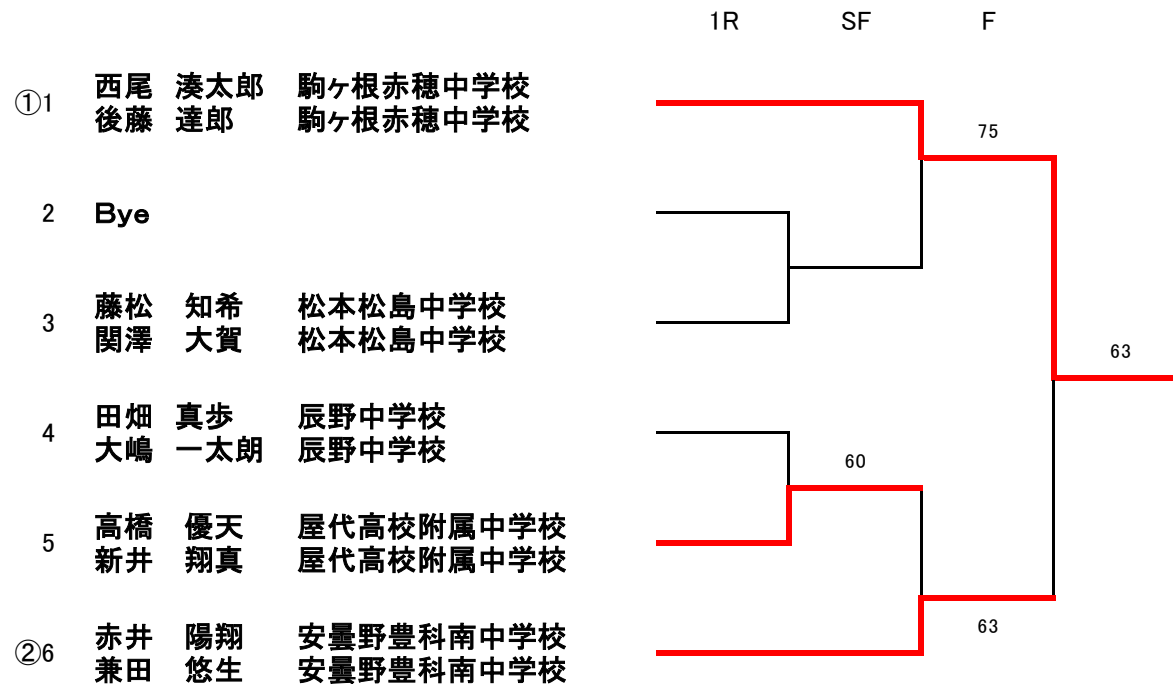

## 順位決定戦

### 3位決定戦

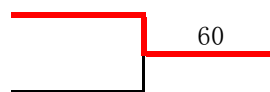
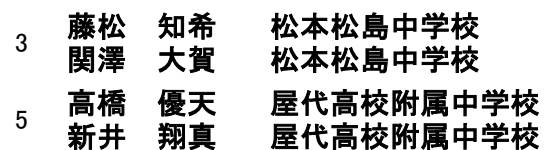

# 中学女子ダブルス(5)

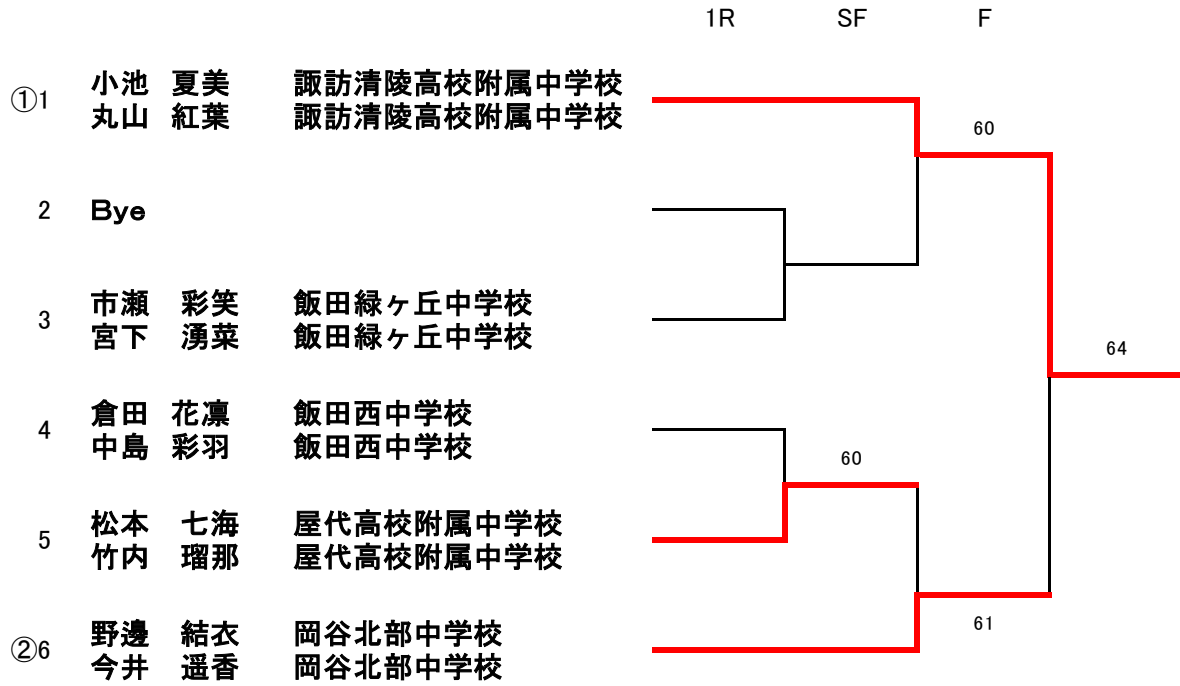

## 順位決定戦

### 3位決定戦

